

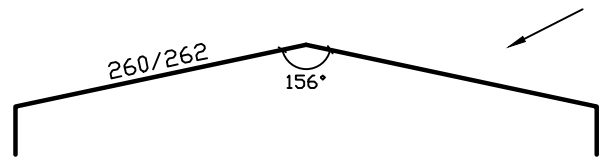
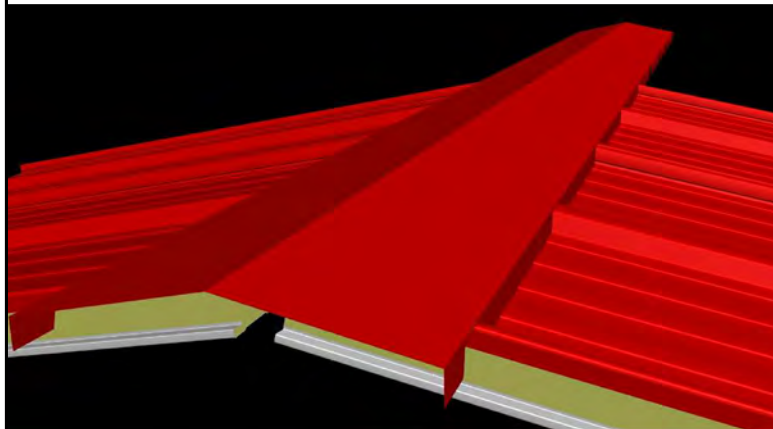
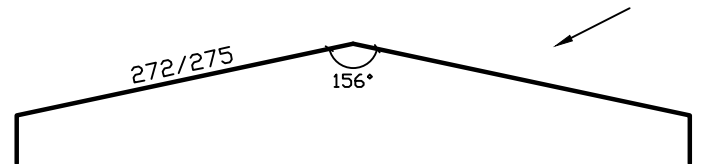
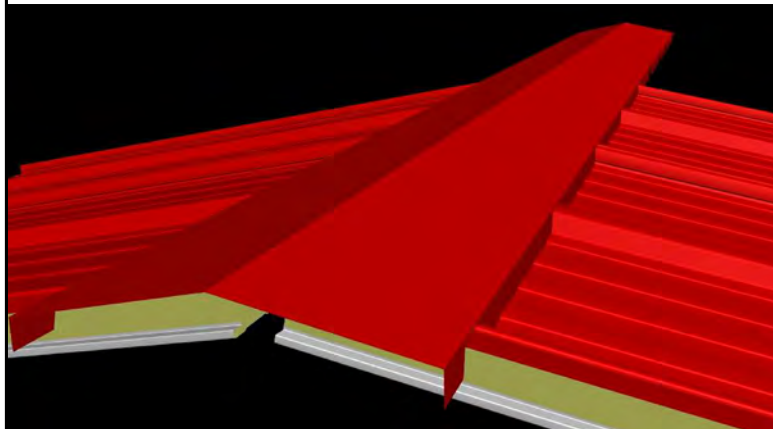

REMATES

CUMBRERA TROQUELADA AIS TAP/3G/5G

DESARROLLO	600
LARGO	3200
OBS.	LARGO UTIL 3000

CUMBRERA SIN TROQUELAR AIS TAP/3G/5G (CAJEO EN OBRA)

DESARROLLO	625
LARGO	3000 O 6000 MM
OBS.	CAJEAR EN OBRA

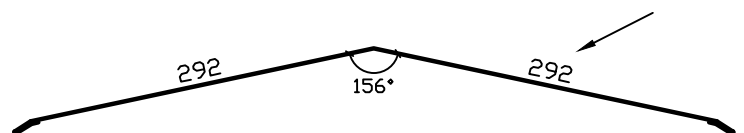
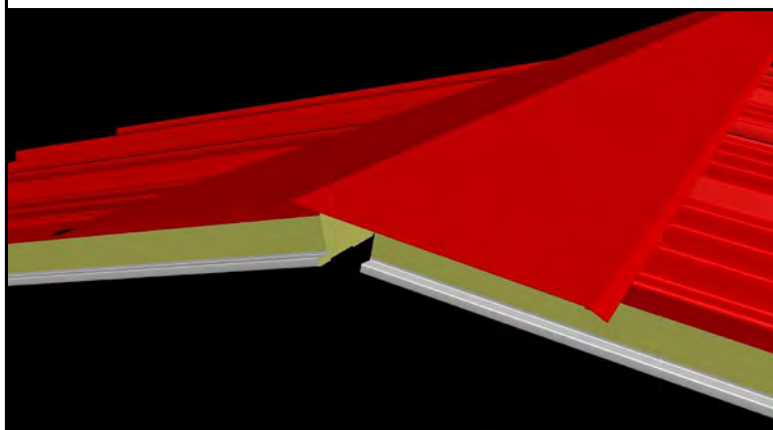
CUMBRERA LISA D625

DESARROLLO	625
LARGO	3000 O 6000 MM
OBS.	

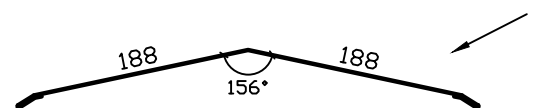
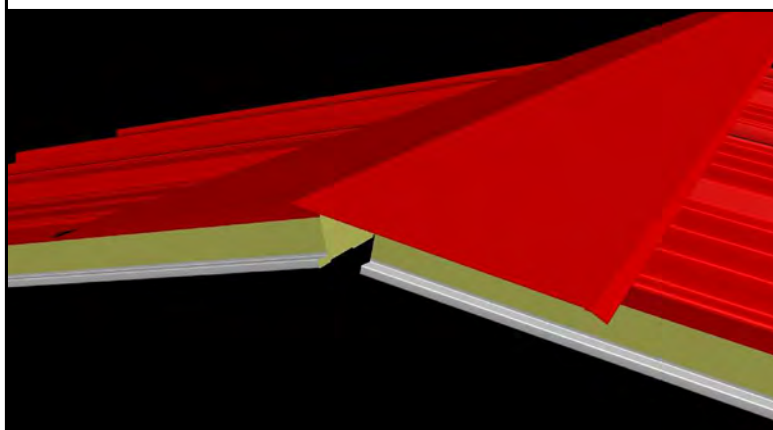
CUMBRERA LISA D416

DESARROLLO	416
LARGO	3000 O 6000 MM
OBS.	

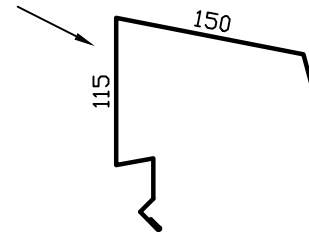
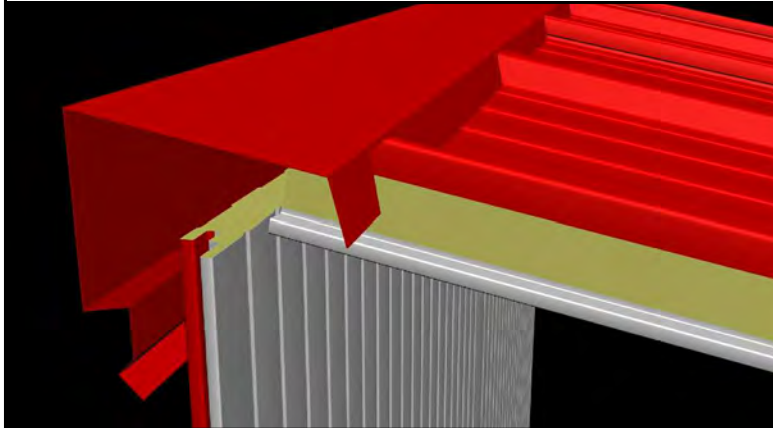
CORONACIÓN TRASERA TROQUELADA AIS TAP/3G/5G

DESARROLLO	407/410
LARGO	3200
OBS.	LARGO UTIL 3000

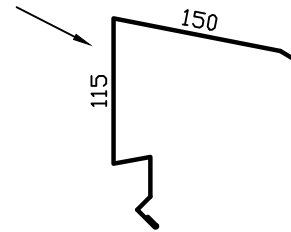
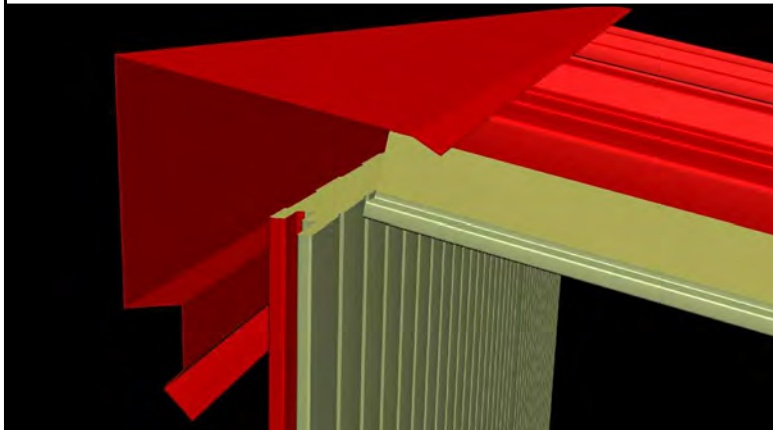
CORONACIÓN TRASERA SIN TROQUELAR

DESARROLLO	370
LARGO	3000 O 6000 MM
OBS.	

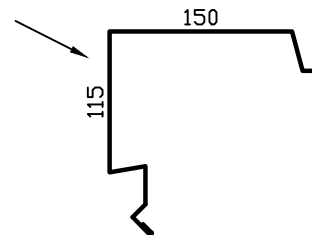
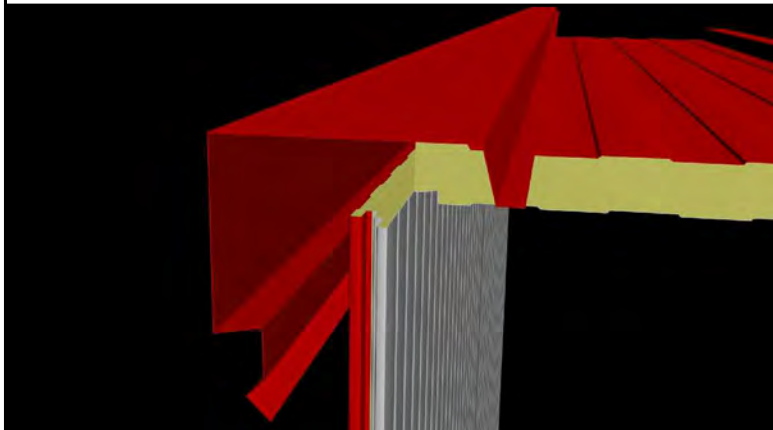
CORONACIÓN LATERAL AIS TAP/3G/5G

DESARROLLO	416
LARGO	3000 O 6000 MM
OBS.	

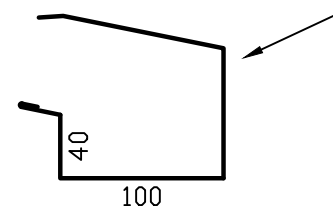
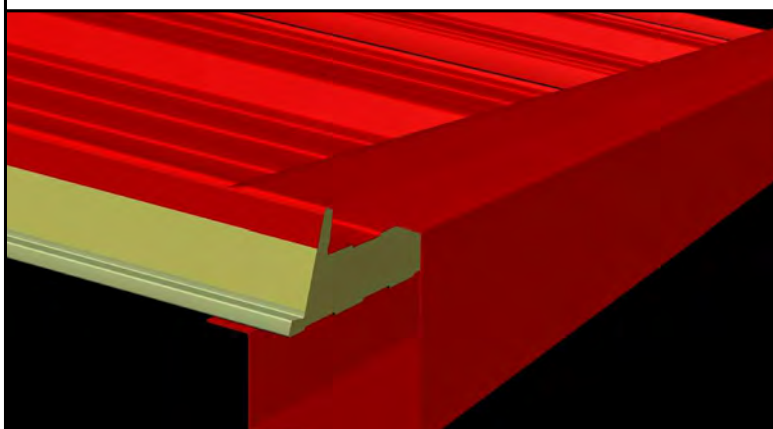
FRONTAL CANALON AIS TAP/3G/5G

DESARROLLO	HASTA 416
LARGO	3000 O 6000 MM
OBS.	

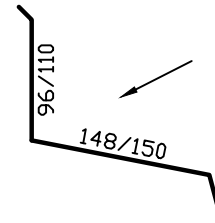
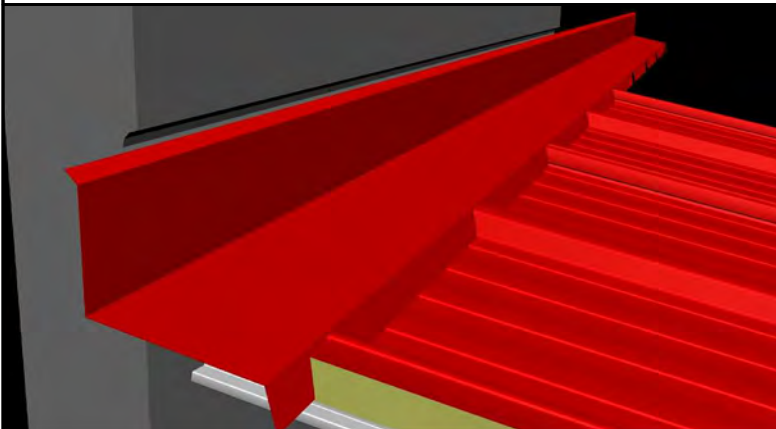
FALDON TRASERO TROQUELADO AIS TAP/3G/5G

DESARROLLO	300
LARGO	3200
OBS.	LARGO UTIL 3000

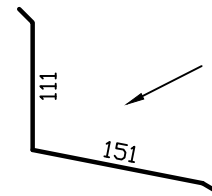
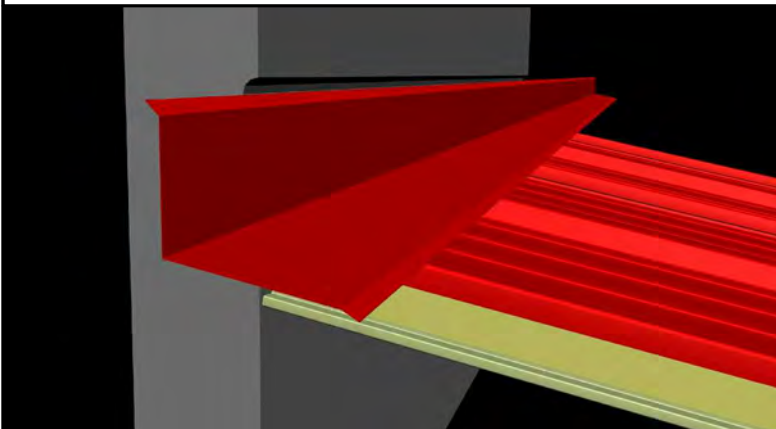
FALDON TRASERO SIN TROQUELAR

DESARROLLO	266
LARGO	3000 O 6000 MM
OBS.	

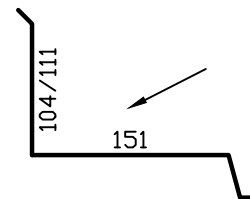
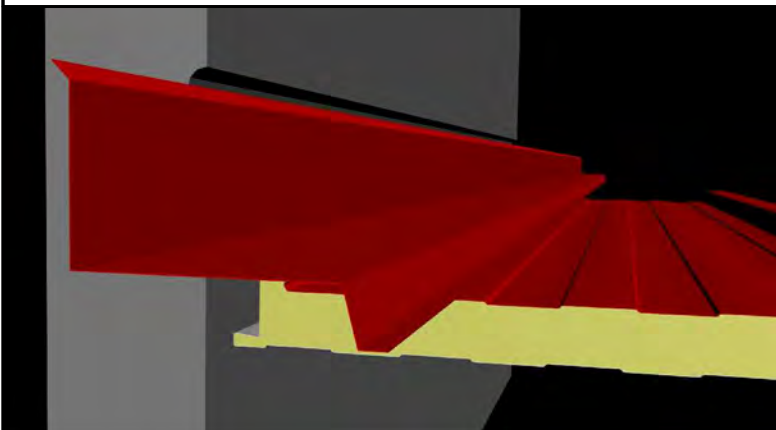
FALDON LATERAL AIS TAP/3G/5G

DESARROLLO	312
LARGO	3000 O 6000 MM
OBS.	

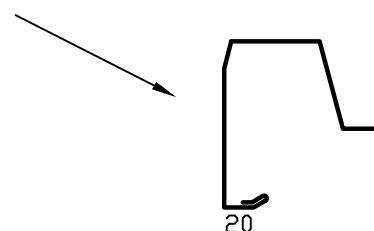
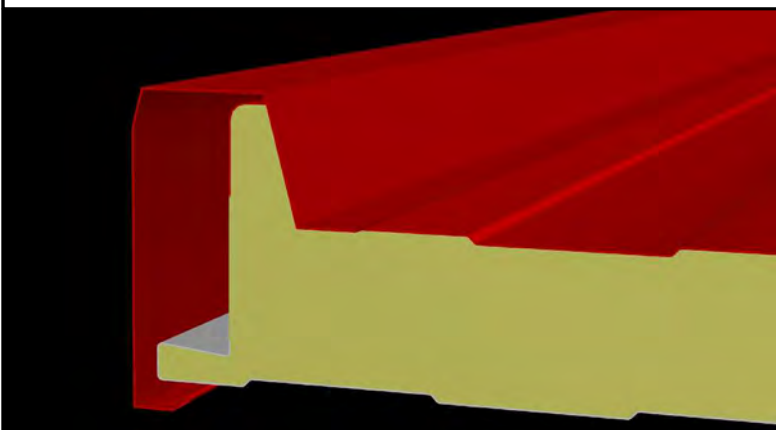
LATERAL VUELO AIS TAP/3G /5G

DESARROLLO	HASTA 239
LARGO	3000 O 6000 MM
OBS.	

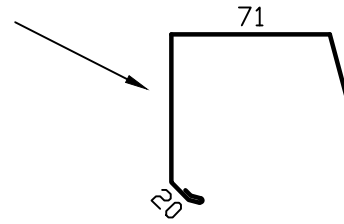
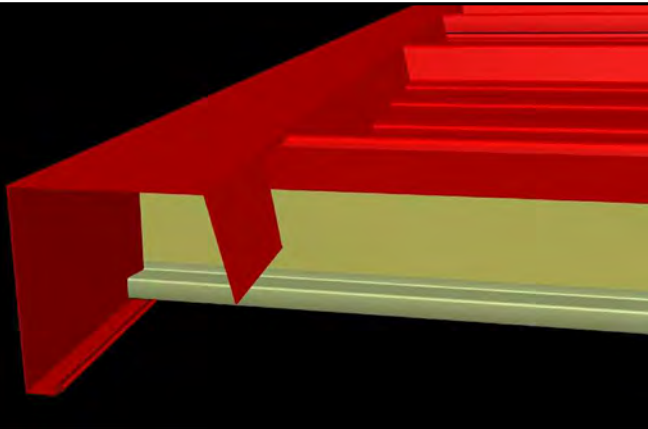
CORONACIÓN VUELO TROQUELADA AIS TAP/3G/5G

DESARROLLO	HASTA 300
LARGO	3200
OBS.	LARGO UTIL 3000

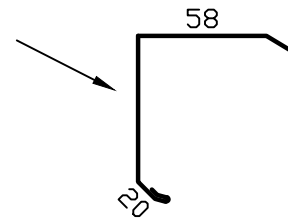
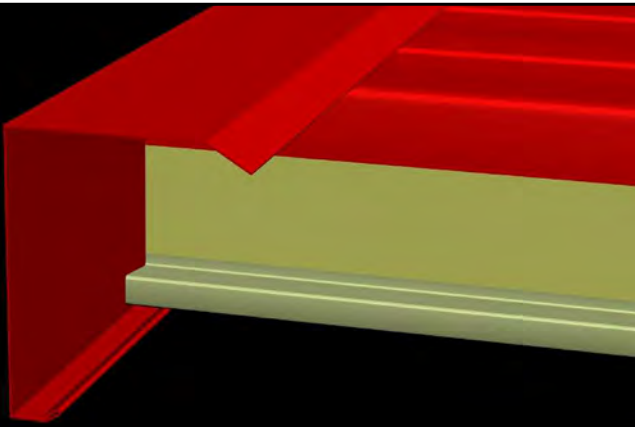
FRONTAL VUELO SIN TROQUELAR AIS TAP/3G/5G

DESARROLLO	HASTA 250
LARGO	3000 O 6000 MM
OBS.	

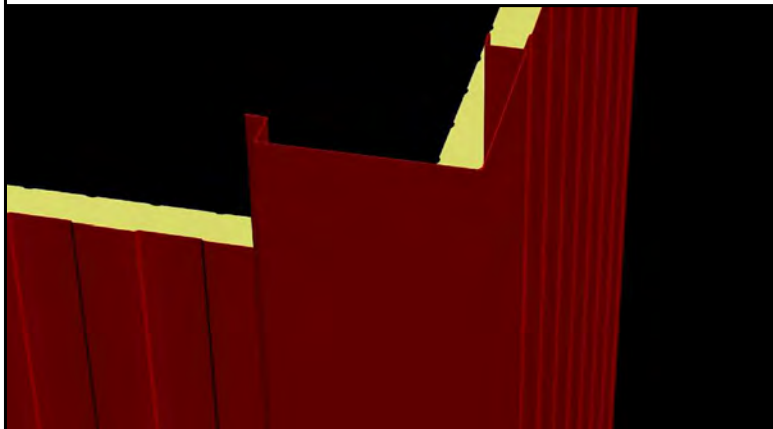
ESQUINERO EXTERIOR

DESARROLLO	416
LARGO	3000 O 6000 MM
OBS.	

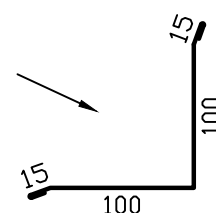
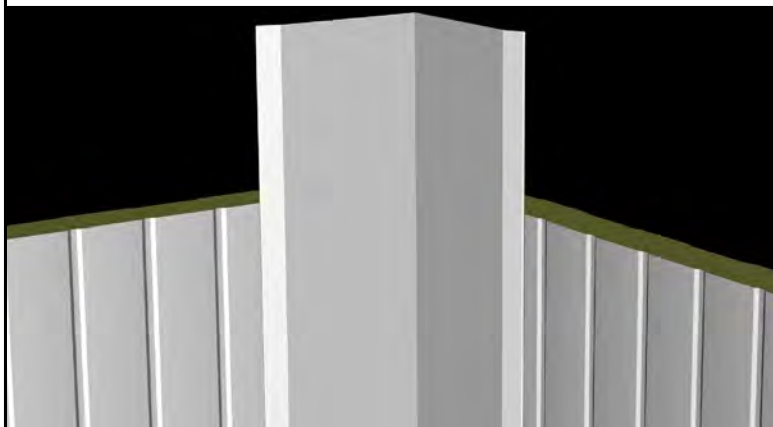
ESQUINERO INTERIOR

DESARROLLO	250
LARGO	3000 O 6000 MM
OBS.	

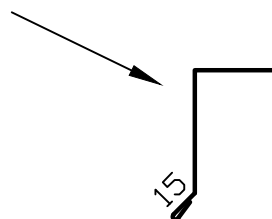
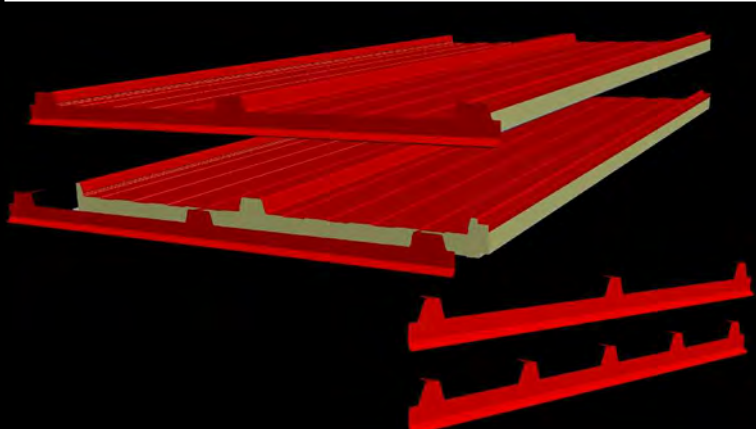
FRONTAL AIS TAP/3G/5G

DESARROLLO	153
LARGO	1100
OBS.	LARGO UTIL - 1000

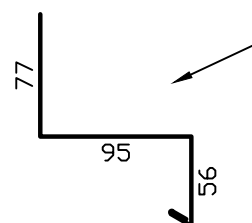
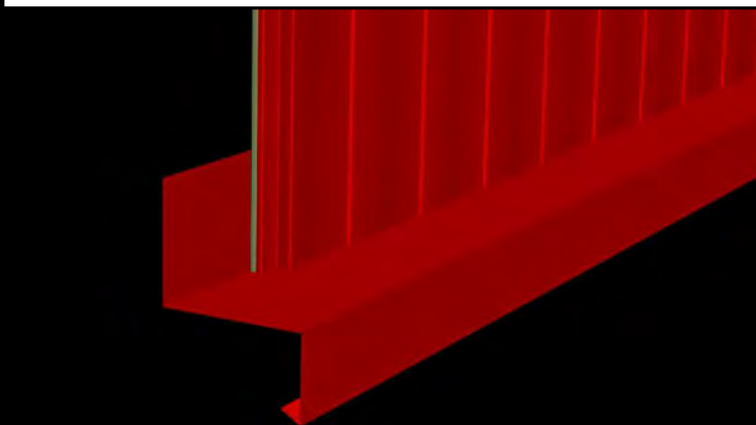
PIE FACHADA O VIERTEAGUAS

DESARROLLO	250
LARGO	3000 O 6000 MM
OBS.	

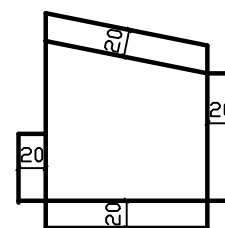
TAPA CANALÓN AIS TAP/3G/5G

DESARROLLO	
LARGO	
OBS.	SE VENDEN POR PAREJAS

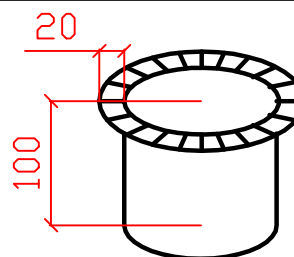
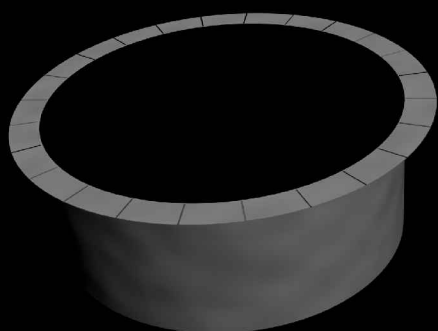
BOQUILLA BAJANTE CANALÓN GALVANIZADA

DESARROLLO	
LARGO	
OBS.	ØMIN:70 - ØMÁX: 150

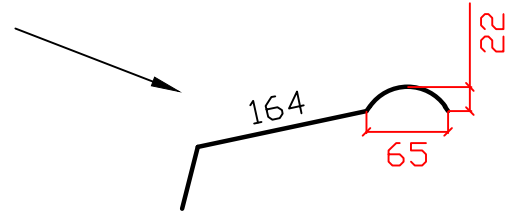
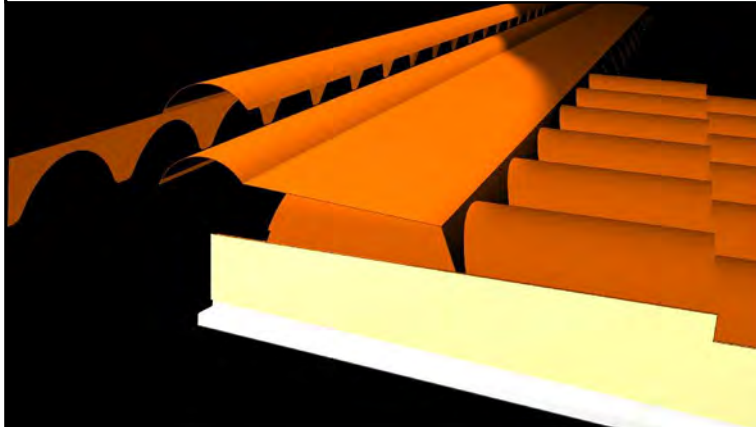
CUMBRERA DOBLE AIS NCOPPO

DESARROLLO	2x300
LARGO	3000
OBS.	LARGO UTIL 2800

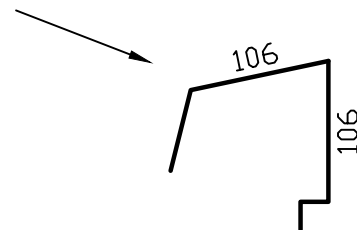
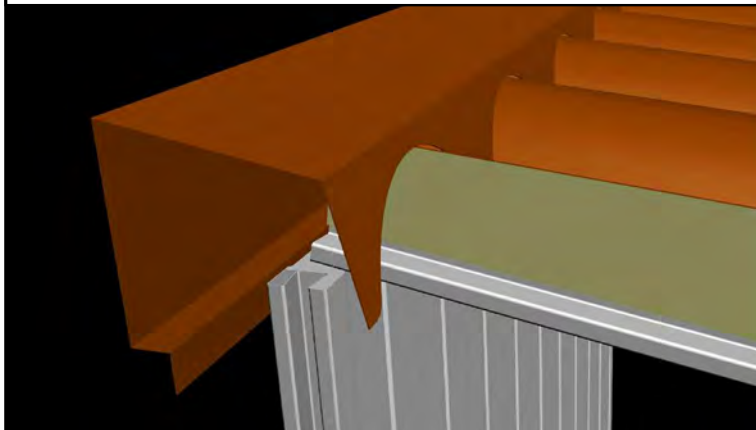
CORONACIÓN TRASERA TROQUELADA AIS NCOPPO

DESARROLLO	300
LARGO	3000
OBS.	LARGO UTIL 2800

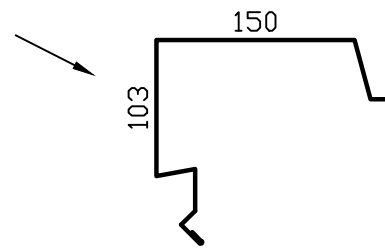
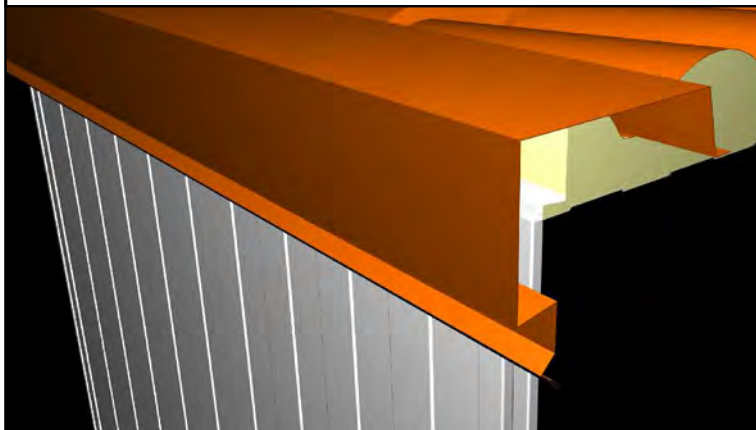
CORONACIÓN LATERAL AIS NCOPPO

DESARROLLO	416
LARGO	3000 O 6000 MM
OBS.	

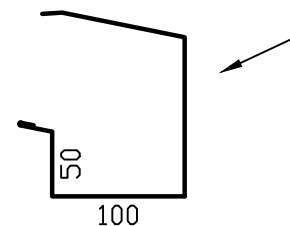
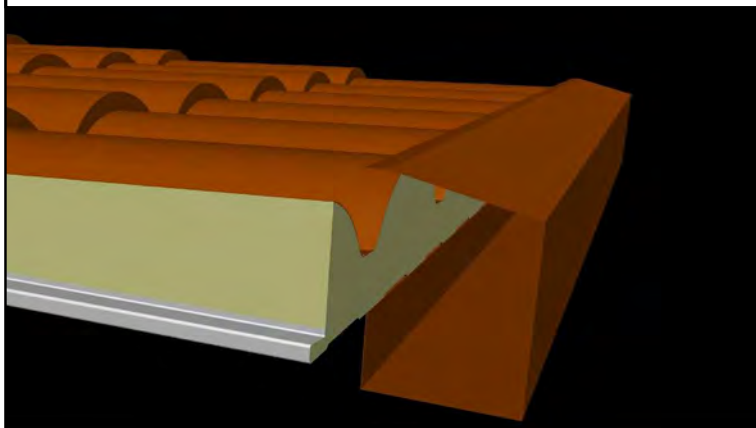
FRONTAL CANALÓN AIS NCOPPO

DESARROLLO	411
LARGO	3000 O 6000 MM
OBS.	

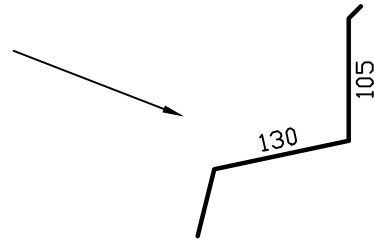
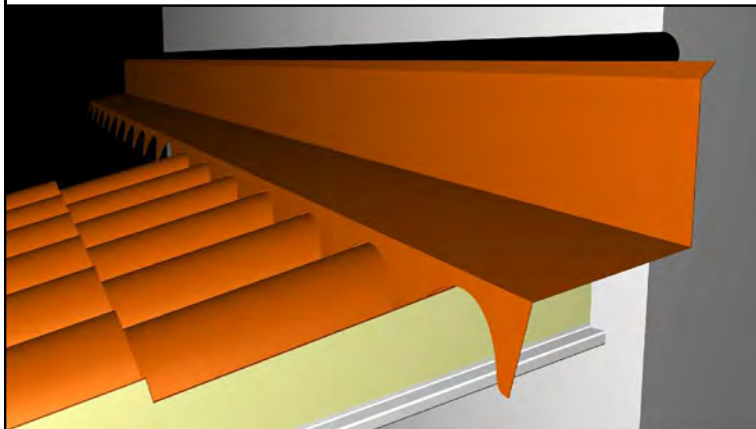
FALDÓN TRASERO TROQUELADO AIS NCOPPO

DESARROLLO	300
LARGO	3000
OBS.	LARGO UTIL 2800

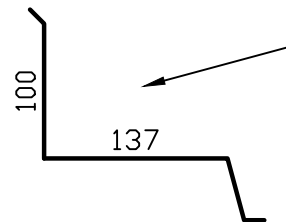
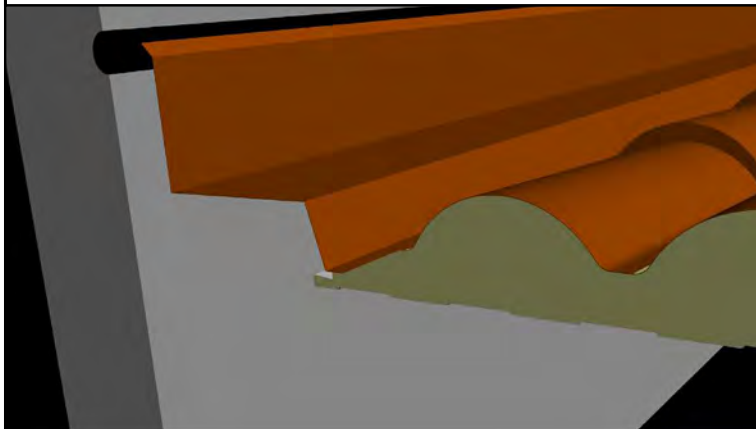
FALDÓN LATERAL AIS NCOPPO

DESARROLLO	312
LARGO	3000 O 6000 MM
OBS.	

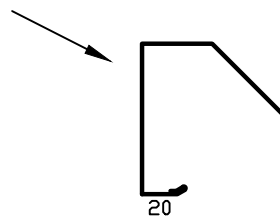
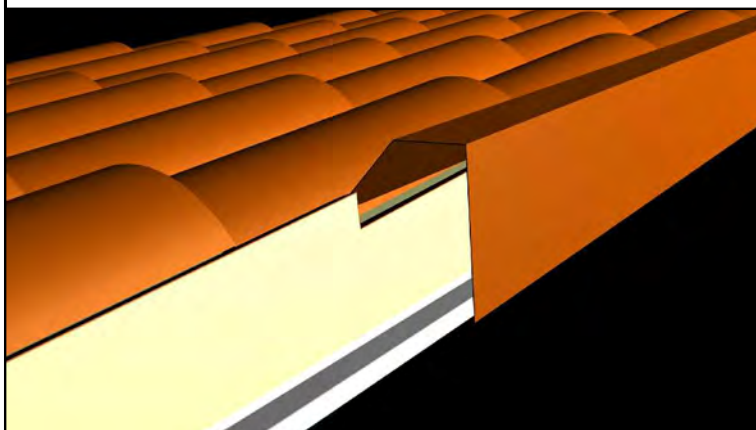
LATERAL VUELO AIS NCOPPO

DESARROLLO	250
LARGO	3000 O 6000 MM
OBS.	

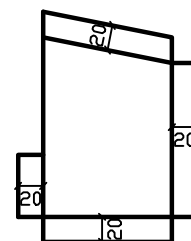
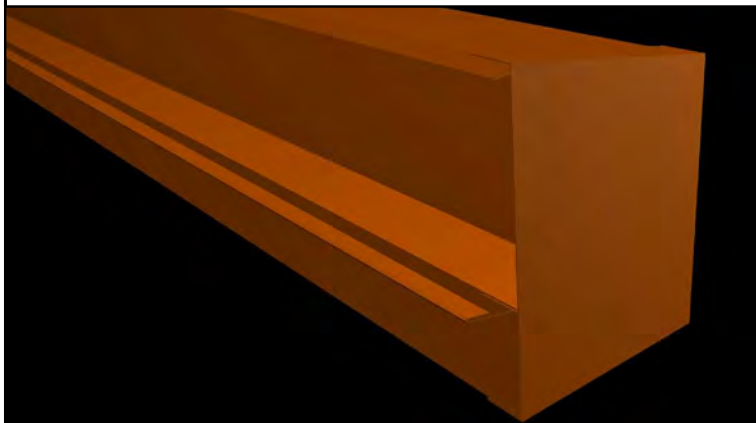
TAPA PARA CANALÓN DE NCOPPO

DESARROLLO	
LARGO	
OBS.	SE VENDEN POR PAREJAS

REMATE FRONTAL AIS NCOPPO

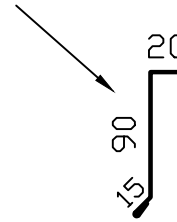
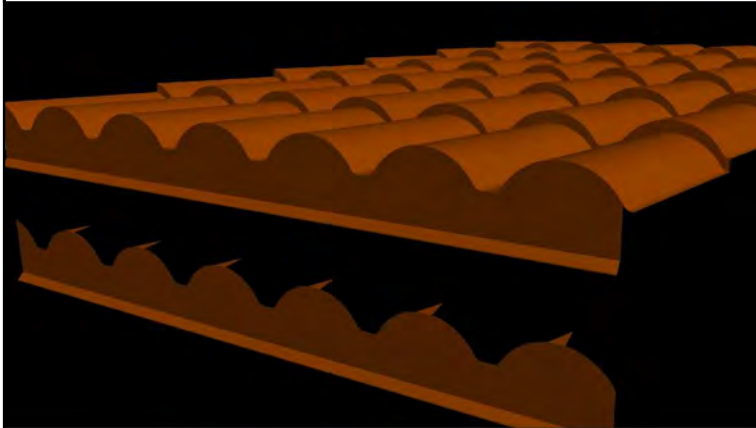

DESARROLLO	136
LARGO	1055
OBS.	LARGO UTIL 1000

AIREADOR ESTÁTICO BOCA 250

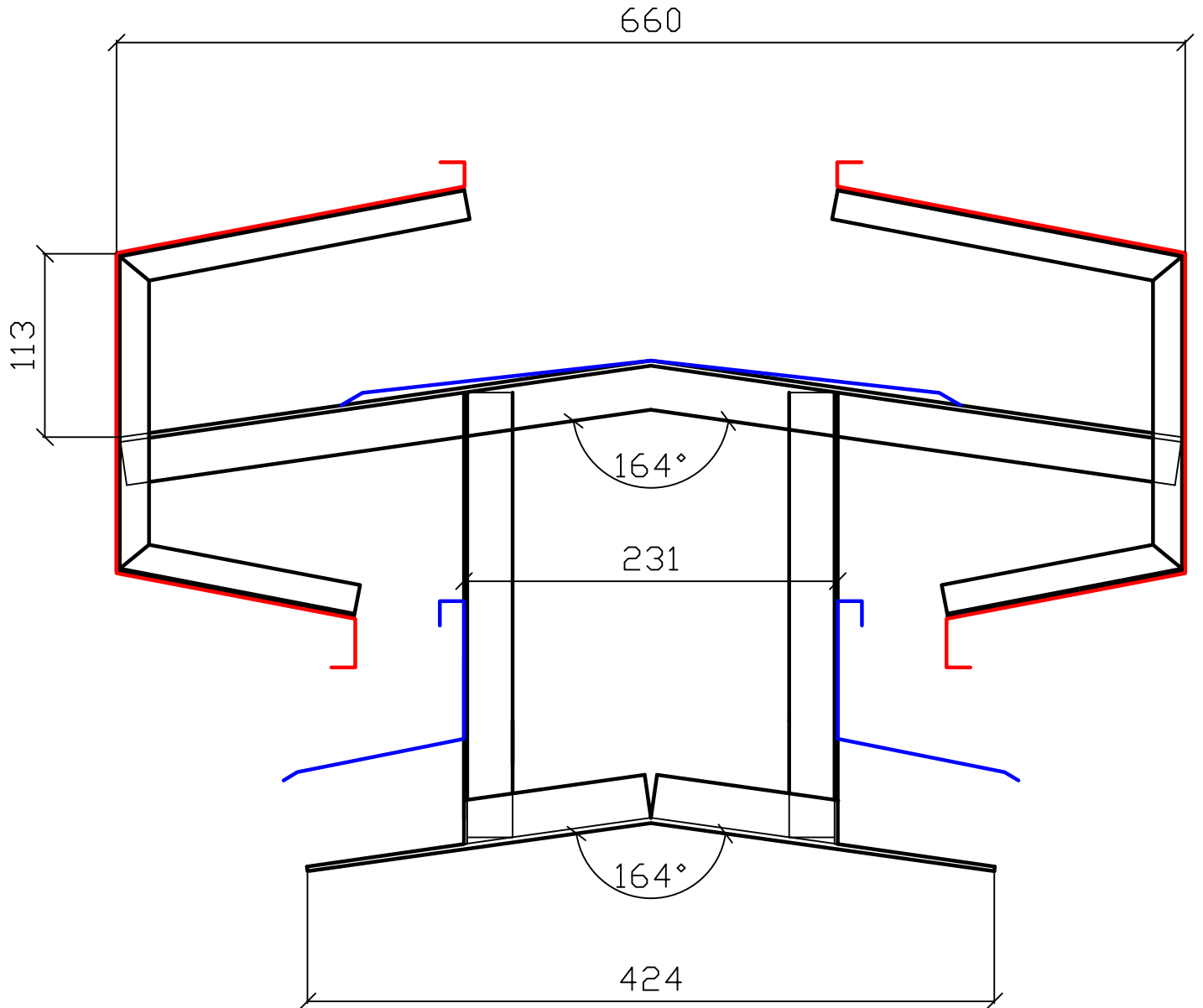

AIREADOR ESTÁTICO BOCA 500

